

Tools Needed



#2 Square Head Bit



Electric Drill



Level or Straight Edge

Each fence section kit will include the following:

Styles A & D Standard Picket: 15 pickets per section, 3 rails with punched picket holes, 45 self drilling screws.

Styles A & D Double Picket: 31 pickets per section, 3 rails with punched picket holes, 93 self drilling screws.

Styles A & D Puppy Picket: 15 **Full Length** pickets per section, 4 rails with punched picket holes, 16 **Puppy Pickets** per section, 92 self drilling screws.

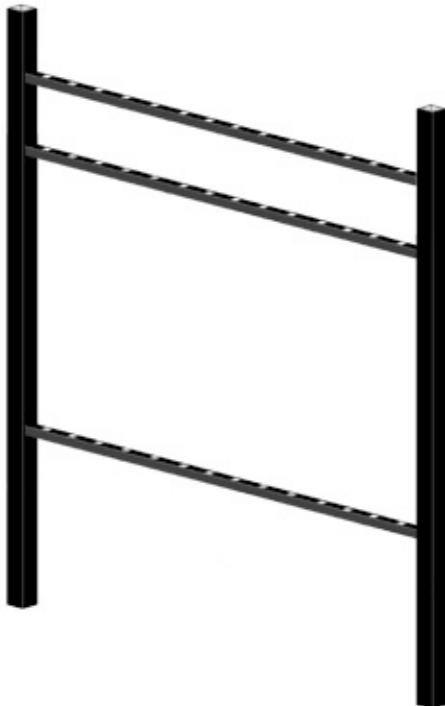

Assembly

Step 1: Place 2 posts on a level flat surface with the routed rail holes facing each other. Note: if you did not purchase posts, please refer to the rail spacing below on the specification drawings.

Step 2: Insert all of the rails into the post holes.



Step 3: Insert pickets into each picket hole.

Note: On Style D sections, start on the end with a short pressed point picket.

Step 4: Once you have installed all of the pickets in the rails, refer to the specification drawings below for how much of the picket protrudes out of the top rail for your specific fence height. Set the correct height on both end pickets.

Step 5: Using an electric drill with a #2 square bit, screw each END picket to the rails through the pre-drilled holes.

Step 6: Once the end pickets are secure, use a level or straight edge across the bottom of the secured end pickets to insure that the unattached pickets are even and straight.

Step 7: Using an electric drill with a #2 square bit, screw each picket to the rails through the pre-drilled holes.

Step 8: Remove posts from ends. Your assembled section is now ready to be installed. Please visit www.onlinefencesupply.com to view our recommended aluminum fencing installation instructions.

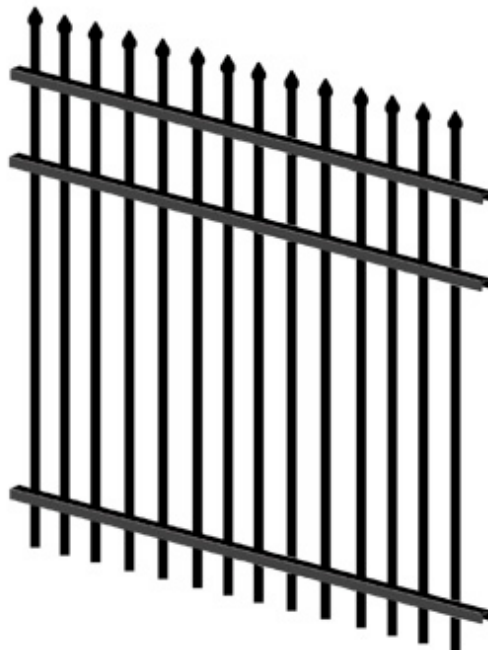

Style A Residential Aluminum Fencing - 3 Rail Picket Top

Specifications

Material: 6063-T5 Aluminum • Pickets: 5/8" sq. x .050" Wall • Rails: 1" sq. x .055" Wall • PPG® TGIC Polyester Powder Coating

Screws: Hardened 410 Stainless Steel With Cr6 Plating & Colored Heads • All Sections Are Offered Pre-Assembled Or Un-Assembled

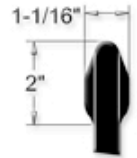

Picket Detail

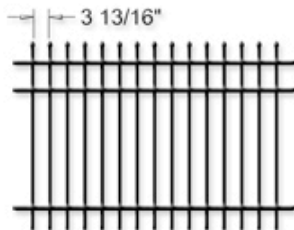
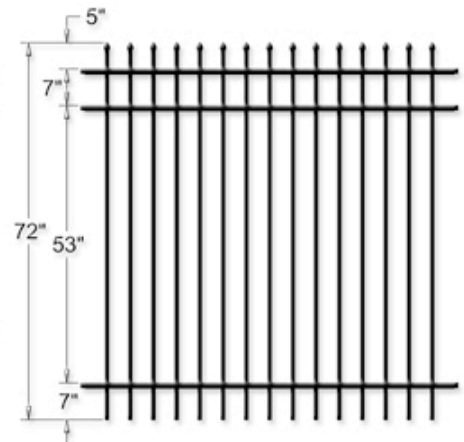
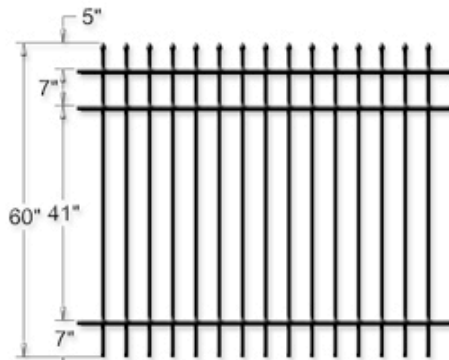
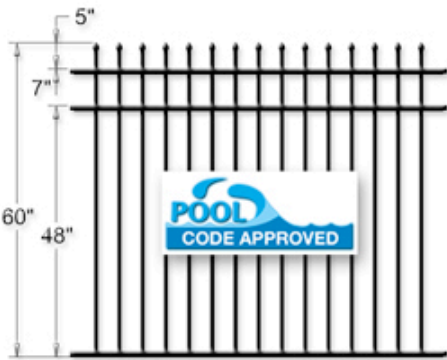
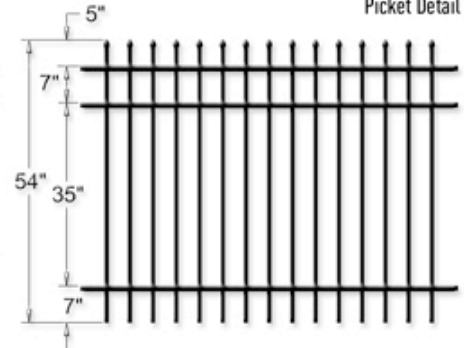
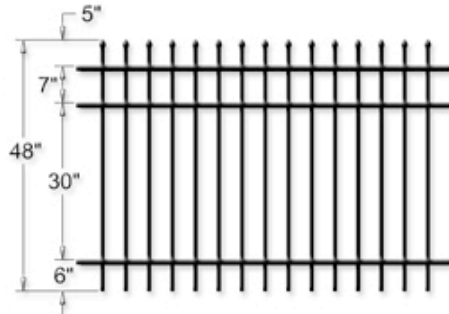
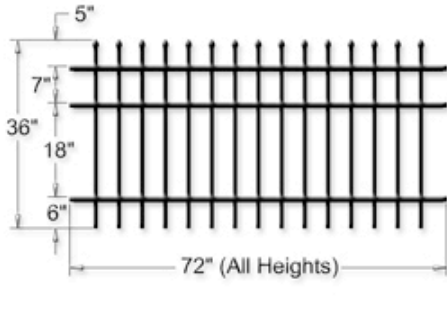

Standard Picket

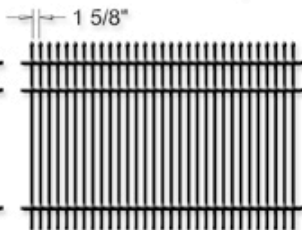

Double Picket

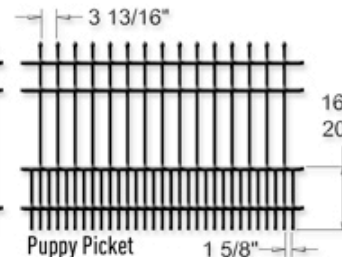

Puppy Picket

16" (36" & 48" Heights)
20" (54", 60" & 72" Heights)

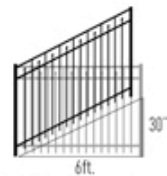

Sections can rack 30" over the 6ft. span to accommodate hilly terrain.

Style A Aluminum Fence Sections Are Available In Standard Picket, Double Picket & Puppy Picket Designs.

Style D Residential Aluminum Fencing - 3 Rail Alternating Picket Top

Specifications

Material: 6063-T5 Aluminum • Pickets: 5/8" sq. x .050" Wall • Rails: 1" sq. x .055" Wall • PPG® TGIC Polyester Powder Coating

Screws: Hardened 410 Stainless Steel With Cr6 Plating & Colored Heads • All Sections Are Offered Pre-Assembled Or Un-Assembled

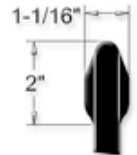

Picket Detail

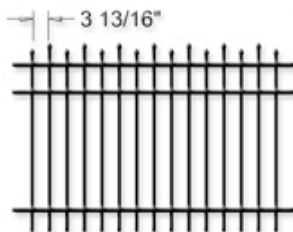
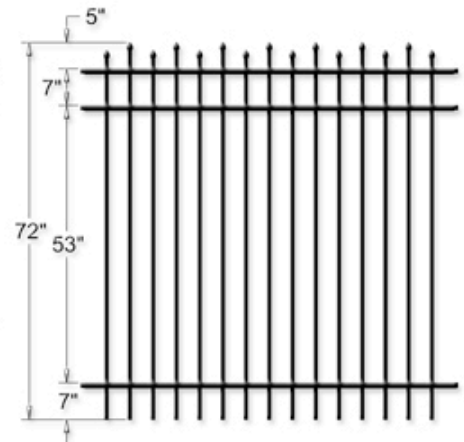
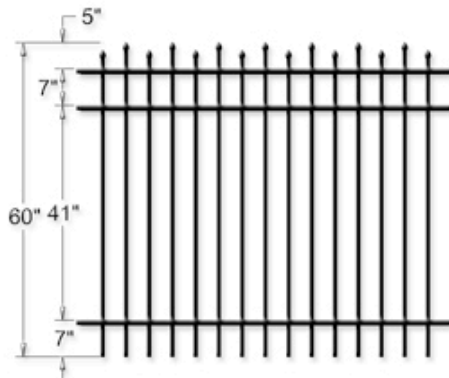
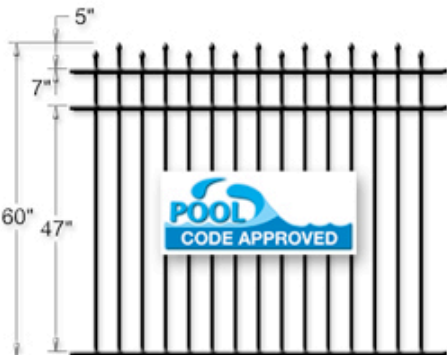
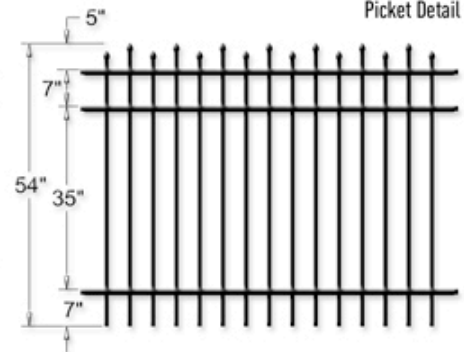
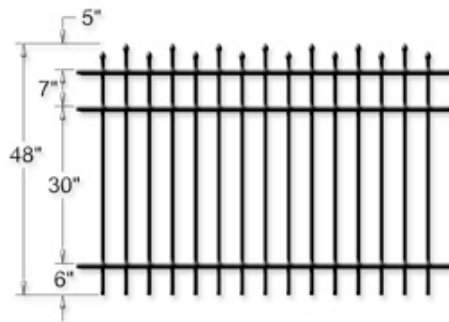
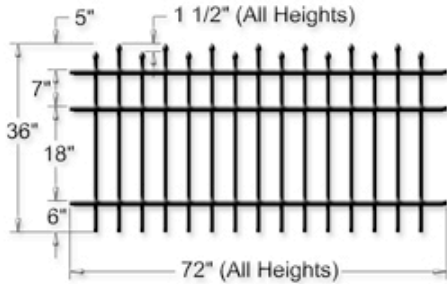

Standard Picket

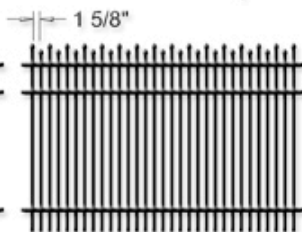

Double Picket

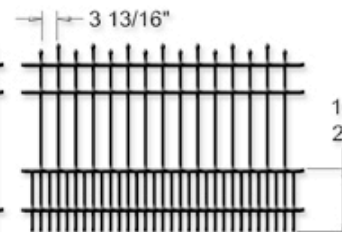

Puppy Picket

16" (36" & 48" Heights)
 20" (54", 60" & 72" Heights)

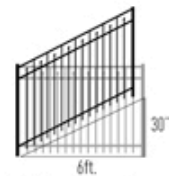

Sections can rack 30" over the 6ft. span to accommodate hilly terrain.

Style D Aluminum Fence Sections Are Available In Standard Picket, Double Picket & Puppy Picket Designs.